



## 2019 Cleveland Race Week – Offshore

Organizing Authority: Edgewater Yacht Club (EWYC)

June 21-24, 2019

### SAILING INSTRUCTIONS

*The notation '[DP]' in a rule in the SI means that the penalty for a breach of that rule may, at the discretion of the protest committee, be less than disqualification*

*The notation '[NP]' in a rule in the SI means that instruction is not grounds for protest or a request for redress by a boat. This changes RRS 60.1.*

#### 1 RULES

- 1.1 The regatta is governed by the rules as defined in the current *Racing Rules of Sailing* (RRS).
- 1.2 US Sailing prescription to RRS 63.2 and 63.4 shall not apply.
- 1.3 RRS Appendix V including V1 and V2 shall apply as changed by SI 13.2.

#### 2 NOTICES TO COMPETITORS AND INFORMATION MEETING(S)

- 2.1 Notices to competitors shall be posted on the official notice board located by the outdoor Clubhouse grill. Scores will be posted in the tent North of the Clubhouse.

#### 3 CHANGES TO SAILING INSTRUCTIONS

- 3.1 Except for instructions 3.2 and 3.3 below, any change to the sailing instructions shall be posted not less than two (2) hours prior to the first scheduled race on the day it shall take effect.
- 3.2 Any change to the location of a racing area shall be posted before 0800 on the day it will apply.
- 3.3 Any change to the schedule of races will be posted by the later of 1800 or the protest time limit on the day before it will take effect.

#### 4 SIGNALS MADE ASHORE

- 4.1 Signals made ashore shall be displayed from the flagpole located north of the EWYC clubhouse.
- 4.2 When flag AP is displayed ashore, "1 minute" is replaced with "not less than 60 minutes" in race signal AP. *This changes race signals AP*
- 4.3 Since numeral pennants are used as class flags, the RRS Race Signals section "AP over a numeral pennant 1-9" is deleted in its entirety.
- 4.4 When a signal flag is posted ashore, the code flag corresponding to each course name shall be displayed to indicate which course the signal is designated for. If no course designator is posted, the signal shall be for all courses.

#### 5 SCHEDULE OF RACES

- 5.1 A total of seven (7) races are scheduled for CRW Offshore Classes.

<u>Race</u>	<u>Type</u>	<u>Day/Date</u>	<u>First Warning</u>
North Coast/Mather	Fixed and Drop Marks	Thursday, June 20	6:55 PM
Stewart/Jones/Schnur	Fixed and Drop Marks	Friday, June 21	6:55 PM
50+ Race	Drop Marks	Saturday, June 22	9:55 AM
McCrone Memorial Race	Drop Marks	Sunday, June 23	9:55 AM

- 5.2 One (1) race each is schedule for both Thursday and Friday CRW Offshore Classes
- 5.3 Back-to-back races are scheduled for Saturday and Sunday.
- 5.4 Second and subsequent races for each class/division will start shortly after last finisher of that class' preceding race.
- 5.5 After the first race of the day, the Race Committee may change the start order to facilitate the timely start of the next race. Class flags will determine the start order.

5.6 No warning signal will be made after 1:00 PM on the last scheduled day of racing

## 6 CLASS FLAGS AND INITIAL ORDER OF START

Class flags and order of start for the first race on each day are shown in Illustration 5 & 6.

## 7 RACING AREA

7.1 North Coast Race (Thursday) & Stewart/Jones/Schnur Race (Friday) The start will be 1 NM North of EWYC "X".

7.2 All Saturday and Sunday Races: Race Area Bravo will be in the vicinity of N41 31.00 W81 47.5  
Charlie will be in the vicinity of N41 31.00 W81 45.50

## 8 THE COURSES

8.1 Thursday Courses rounding directions & mark descriptions will be posted on the Official Notice Board. See "Courses - Illustration 1, & 2"

8.2 Friday Courses, rounding directions & mark descriptions will be posted on the Official Notice Board. See "Courses - Illustration 2 and 3"

8.3 Saturday & Sunday the diagrams in Illustration 4 show the courses, including the order in which marks are to be passed, and the side on which each mark is to be left.

8.4 Saturday & Sunday the RC intends to set a gate at the leeward end of the course. However, a single leeward mark may be set, in which case it shall be left to port.

8.5 The approximate magnetic bearing and distance in nautical miles to the first mark will be displayed from the race committee signal boat prior to the warning signal for each race. An example is shown below:

4	Windward/Leeward, four legs
270	Approx. magnetic bearing to weather ma
1.2	1.2 nm to weather mark

## 9 MARKS - Saturday and Sunday

9.1 Mark 1 shall be a **green** inflatable tetrahedron.

9.2 Mark 1a (the Jibe mark) shall be an **orange** inflatable tetrahedrons.

9.3 Marks 2S and 2P shall be an **orange** inflatable tetrahedrons.

9.4 The starting mark shall be either an anchored vessel displaying a staff with an orange flag or a **yellow** inflatable cylinder.

9.5 The finishing mark shall be an **orange** inflatable cylinder.

9.6 New marks, as provided in instruction 11.1, and 11.2 shall be **yellow** inflatable marks.

## 10 THE START

10.1 North Coast Race (Thursday) & Stewart/Jones/Schnur Race (Friday) The start will be between the staffs flying the Orange flag on the Race Committee boat and the mark as described in 9.4.

10.2 Friday and Saturday the Signal vessel will display either an "S" or a "P" on a course board to designate which the direction the first mark will be rounded.

10.3 Saturday and Sunday - The starting line shall be between a staff displaying an orange flag on the signal vessel and the course side of the mark or the staff displaying an orange flag as described in instruction 9.4.

10.4 Boats whose warning signal has not been made shall avoid the starting area during the sequence for other races. [DP][NP]

10.5 A boat that does not start within four (4) minutes of her starting signal shall be scored Did Not Start without a hearing. *This changes rules A4 and A5.*

10.6 If any part of a boat's hull, crew or equipment is on the course side of the starting line after her starting signal and she is identified, the race committee may broadcast her sail number on VHF channel for competitor communication as noted in instruction 22.4. Failure to make a broadcast, the order of sail numbers called, or to time it accurately will not be grounds for a request for redress. *This changes RRS 62.1(a).*

## 11 COURSE CHANGES

11.1 **Before the starting signal** - If there is a significant wind shift during a series of starting sequences, the RC may signal a change of course for a class as follows: A postponement may be signalled to allow the RC to reset the

line. Flag C will be displayed from the signal vessel prior to the warning signal. The magnetic bearing of the new weather mark will be displayed and attention to the change of course will be made by multiple sound signals. The new Mark 1 will be **yellow**, but after a second change during the race, the changed mark will be **green**. Flag C will continue to be displayed to each class for which the yellow Mark 1 applies.

- 11.2 **After the starting signal** - To change the next leg, as allowed by RRS 33, the race committee will lay a new mark, move the finishing line or move the gate and remove the old mark as soon as practicable. When in a subsequent change a new mark is replaced, it will be replaced by an original mark.

## 12 THE FINISH

The finishing line shall be between a staff displaying a **blue** flag on the signal boat or at the finishing area and the course side of the mark as described in instruction 9.5.

## 13 PENALTY SYSTEM

- 13.1 **Penalties at the time of the incident:** The first two sentences of rule 44.1 are changed to: "A boat may take a One-Turn Penalty when she may have broken a rule of Part 2 or rule 31 while racing. However, when she may have broken a rule of Part 2 while in the zone around a mark other than a starting mark, her penalty shall be a Two-Turns Penalty."
- 13.2 Penalties within three (3) boat lengths of Mark 1 or on the leg from Mark 1 to Mark 1a may be delayed and taken as soon as possible on the downwind leg. *This changes RRS 44.2 and V1*
- 13.3 **Penalties after the race:** After a race, a boat that may have broken a rule of Part 2 or rule 31 while racing may take a Post-Race Penalty for that incident. The penalty shall be a 20% Scoring Penalty, calculated as stated in rule 44.3(c). However, rules 44.1(a) and (b) apply and the penalty shall not be taken after a protest hearing involving the incident has begun. A boat takes a Post-Race Penalty by informing the race committee in writing and identifying the race number and when and where the incident occurred.

## 14 TIME LIMITS

- 14.1 The time limit to sail the course and finish are as follows:

<u>Race</u>	<u>Race Time Limit</u>	<u>Mark 1 Time Limit</u>
Thursday Evening	3 hours	1 hour
Friday Evening	4 hours	1 hour
Saturday & Sunday, each race	2 hours	45 minutes

- 14.2 If no boat of the affected class has reached the first mark within one (1) hour, the race shall be abandoned for that class only.
- 14.3 Finishing Window All Classes-Saturday and Sunday only – A boat or boats failing to finish within twenty (20) minutes after the first boat in her class sailed the course and finished, and before the time limit as specified in SI14.1, will be scored Time Limit Expired (TLE) without a hearing. *This changes RRS 35, A4.1, A5 and A11.*

## 15 PROTESTS AND REQUESTS FOR REDRESS

- 15.1 Protest forms are available at race headquarters (the Chart Room) at EWYC. Protests and requests for redress shall be delivered there within the appropriate time limit.
- 15.2 For each class, the protest time limit is one (1) hour after the RC signal vessel for their course area docks after the last race of the day or the RC signals no more racing today, whichever is later.
- 15.3 Notices will be posted no later than thirty (30) minutes after the protest time limit to inform competitors of hearings in which they are parties or named as witnesses. Hearings shall be held in the "Chart Room" inside the main Clubhouse, beginning at the time posted on the official notice board. All parties to Protest Meetings shall meet at the Judges Table 10 minutes prior to their scheduled meeting time; Protest Meetings that do not have all Parties present at its start shall move to the end of scheduled Protest Meetings.
- 15.4 Protests by the RC, Technical Committee (TC) or Protest Committee (PC) shall be posted to inform boats under RRS 61.1(b).
- 15.5 On the last scheduled day of racing a request for redress based on a PC decision shall be delivered no later than thirty (30) minutes after the decision was posted. *This changes RRS 62.2.*
- 15.6 If the RC posts a list of boats scored OCS, ZFP, UFD, BFD or TLE on the official notice board before the protest time limit, a request for redress based on such a posted score shall be made no later than one (1) hour after the after the penalties are posted. *This changes RRS 62.2.*

**16 SCORING**

- 16.1 One (1) race is required to be completed to constitute a series.
- 16.2 Boats scored TLE in accordance with SI 14.3 will receive points equal to the number of boats in her class finishing within the Time Limit as described in SI 14.1 plus one (1) point.
- 16.3 When five (5) or more races have been completed, a boat’s final series score will be the total of her race scores excluding her worst score (one throw-out). This changes RRS A2.
- 16.4 Questions regarding scoring or a boats rating may be resolved by the proper filing of a Scoring Inquiry Form which shall be available in the Chart Room. If the resolution of scoring issue proves unsatisfactory, boats may request redress as available to them under RRS 62.

**17 SAFETY REGULATIONS**

- 17.1 **Check-In** - All boats shall check-in with the Race Committee boat displaying the "L" flag on their assigned race area at least five minutes before the first warning signal of the day. Each boat shall sail past the committee boat on starboard tack and hail her class and sail number until acknowledged by the Race Committee. [DP][NP]
- 17.2 **Retirement** - A boat that retires from a race shall notify the RC as soon as possible. [DP][NP]

**18 EQUIPMENT AND MEASUREMENT CHECKS**

On the water, a boat can be instructed by a member of the RC or TC to proceed immediately to a designated area for inspection. Ashore, equipment may be inspected at any time for compliance with the class rules, notice of race, and sailing instructions.

**19 LAUNCH, HAUL-OUT RESRICTIONS AND TRAILER STORAGE**

- 19.1 All boats must be launched at least three hours before the first warning on her first day of racing. [DP]
- 19.2 Once launched, no boat boats shall be hauled out of the water until after the last race Sunday, except for emergencies, without prior written authorization from the RC. [DP]
- 19.3 All trailers must be moved as directed by EWYC or Race Week personnel. [DP][NP]

**20 DIVING EQUIPMENT AND PLASTIC POOLS**

Underwater breathing apparatus and plastic pools, or their equivalent, shall not be used around boats between the preparatory signal of the first race and the end of the regatta [DP]

**21 RADIO COMMUNICATION**

- 21.1 All radio communications between the RC and the competitors shall be on the VHF channel for each course area as noted on Attachment A.
- 21.2 Various race information, including notification of OCS boats after the start, may be provided by the RC as a courtesy to competitors. This does not in any way alter the competitor’s responsibility to observe the RC’s visual signals which shall govern the conduct of the racing. [NP]
- 21.3 Except in an emergency, a boat shall neither make radio transmissions while racing nor receive radio communications not available to all boats. [DP][NP]
- 21.4 Courses - assigned radio channels.

<b>Signal; Bravo Course - 72</b>	<b>Arc; Charlie Course - 71</b>
----------------------------------	---------------------------------

**22 PRIZES**

- 22.1 First, Second, and Third prizes in each class.
- 22.2 Class perpetual trophies may also be awarded.
- 22.3 Other prizes may be awarded at the discretion of the Organizing Authority and/or individual classes.

**23 DISCLAIMER OF LIABILITY**

Competitors participate in the regatta entirely at their own risk. See RRS 4, Decision to Race. The organizing authority shall not accept any liability for material damage or personal injury or death sustained in conjunction with or prior to, during, or after the regatta.

## Display 1

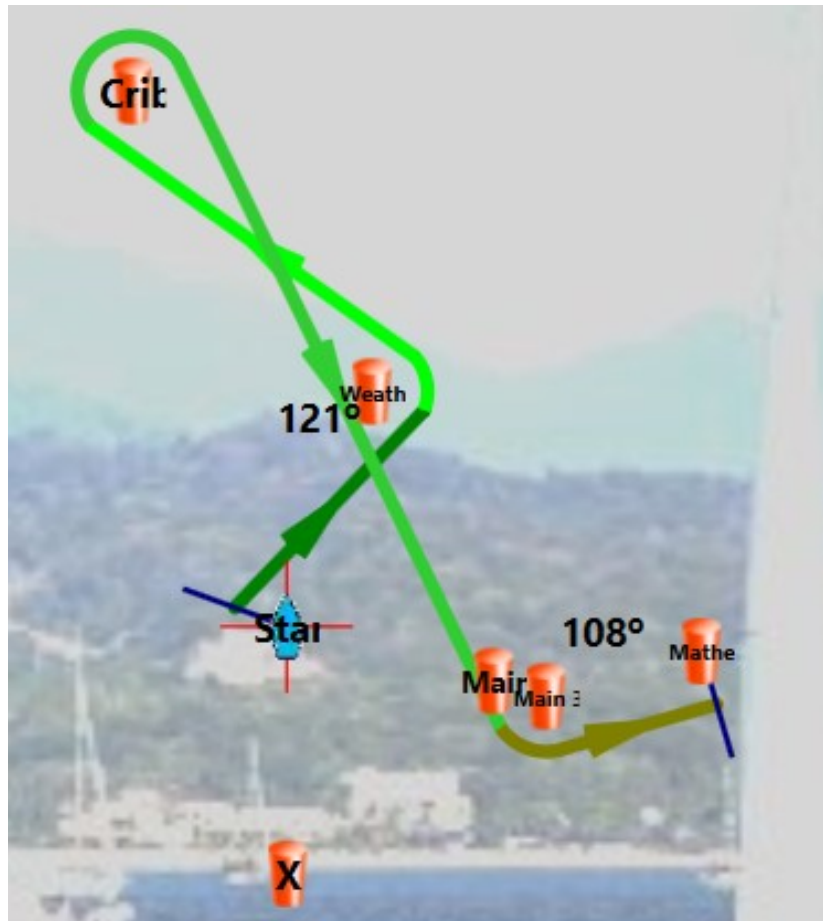

Marks to be rounded in the following order:

Mark	Approx. Bearing to Next Mark	Distance to Next Mark
<b>Committee Boat (s)</b>		.8
<b>Weather(?)</b>		?
<b>Crib (s)</b>	146	2.9
<b>Main Harbor Light #3 (p)</b>	074	.6
<b>Mather (Finish)</b>		
		Total ?

Display is for illustration only, all distances will be calculated from actual GPS coordinates. The committee boat will display an S or P to indicate which side to leave the first mark per the sailing instructions.

## Courses – Illustration 2

### Edgewater Yacht Club – Cleveland Race Week June 20-21, 2019 Offshore Finish Location

Between an orange cylinder near the transom of the William G. Mather and the staff with a blue flag on the Finish boat in the vicinity of R12 and R14 and not impeding the marked navigational channel.

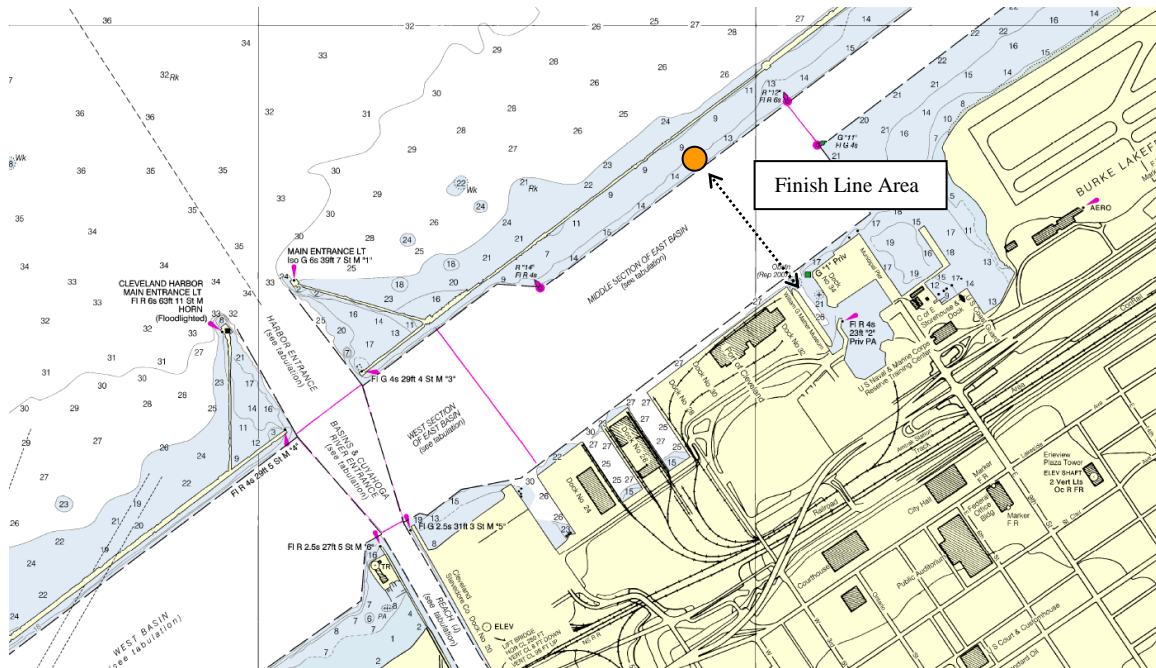

### Display 3

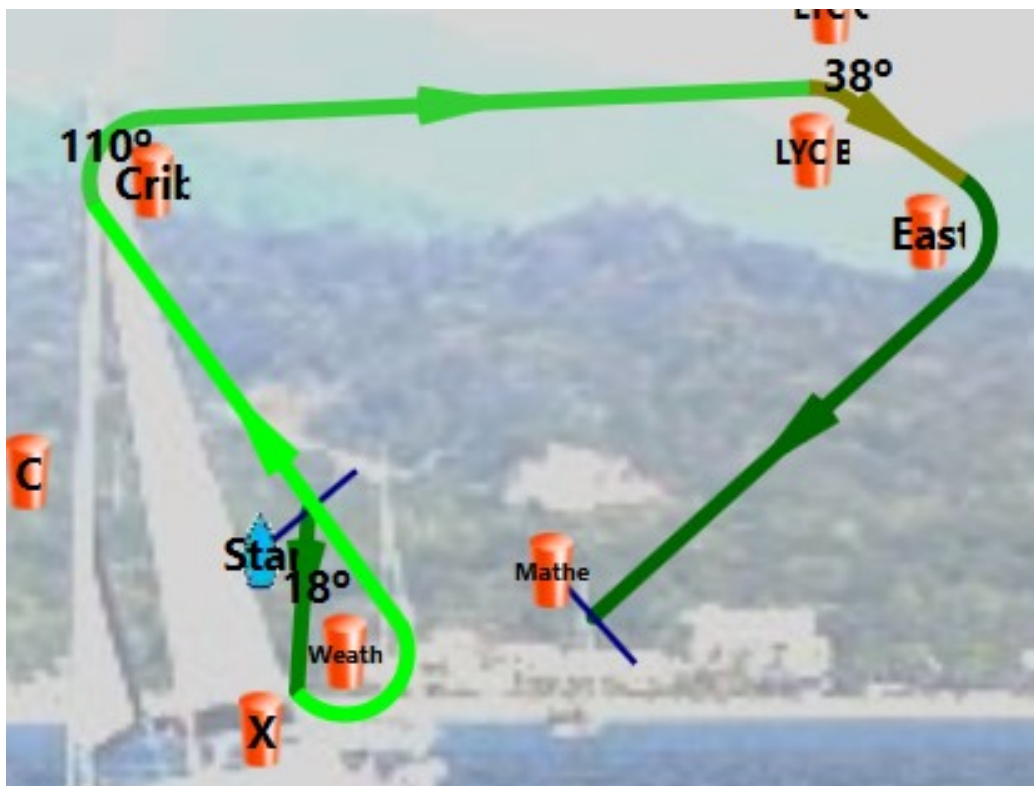

Marks to be rounded in the following order:

Mark	Approx. Bearing to Next Mark	Distance to Next Mark
Committee Boat (s)		.8
Weather(?)		?
Crib (s)	087	3.8
Lakeside B (s)	125	.8
East Light (s)	228	2.9
Mather (Finish)		
		Total ?

Display is for illustration only, all distances will be calculated from actual GPS coordinates. The committee boat will display an S or P to indicate which side to leave the first mark per the sailing instructions.

# COURSES - ILLUSTRATION 4

**COURSE W2**

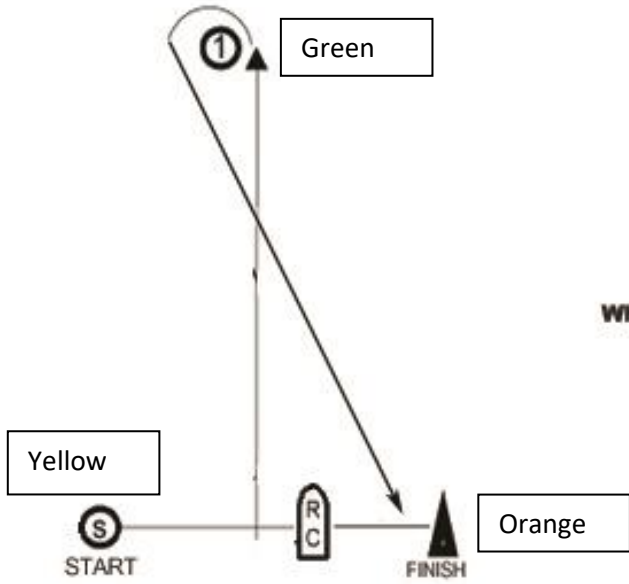

**COURSE W4**

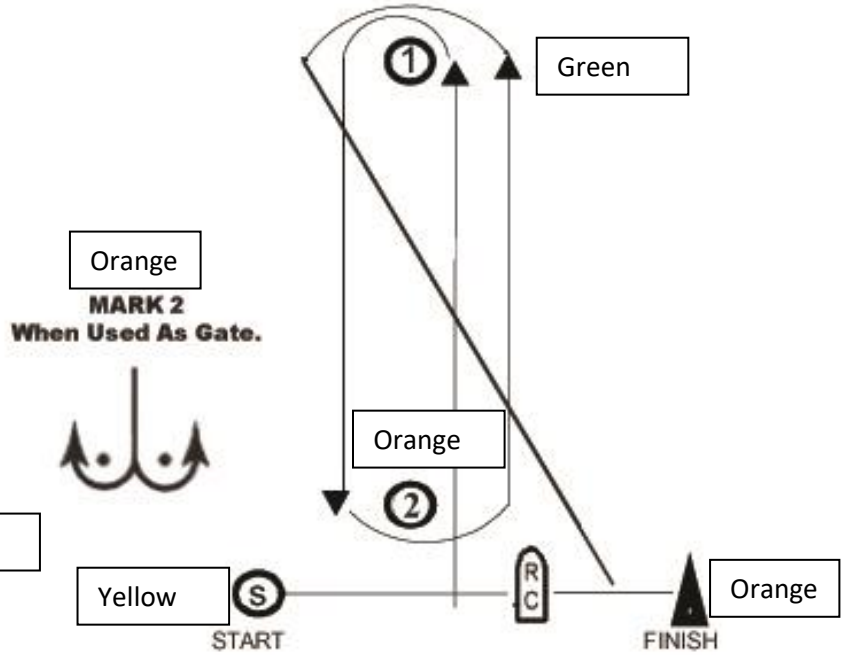

**COURSE W5**

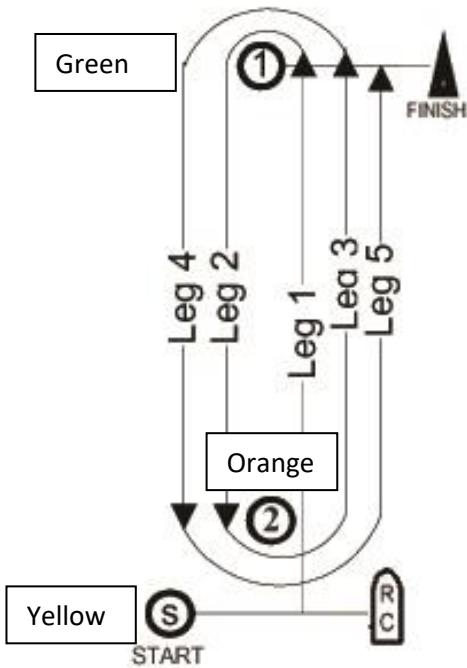

**COURSE O5**

**MARK 2**  
When Used As Gate.

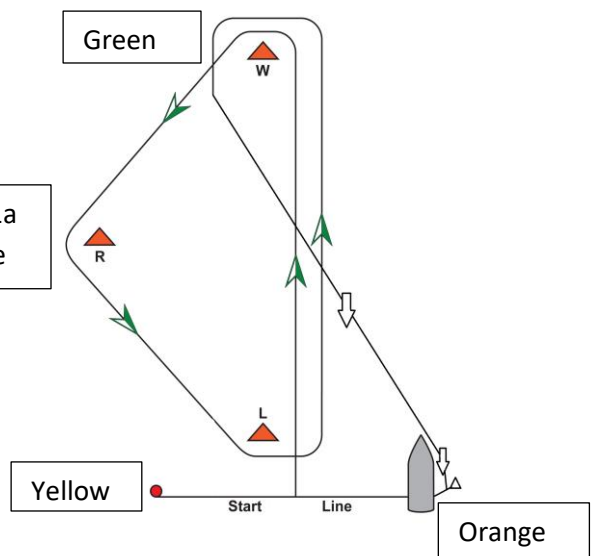







# Illustration 5

## Class Flags and Initial Start Sequence

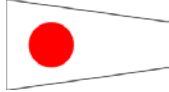
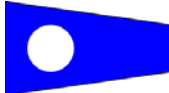
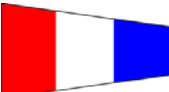
**THURSDAY and FRIDAY ONLY**

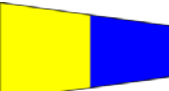

**Ch 71, 1<sup>st</sup> Warning 18:55**

START	Classes	"Class" Flag
1	JAM B JAM C	
2	JAM A	
3	PHRF F PHRF G	
4	PHRF D PHRF E	
5	PHRF B PHRF C	
6	PHRF A	

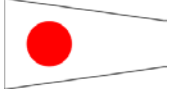
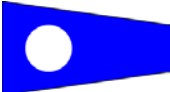
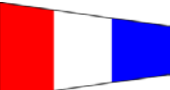

# Illustration 6 Class Flags and Initial Start Sequence

## SATURDAY and SUNDAY ONLY

### Ch. 71

Charlie Course	Class Flag
PHRF A	
PHRF B	
PHRF C	
PHRF D	
PHRF E	

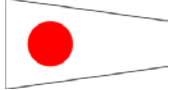
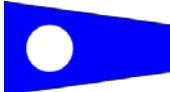
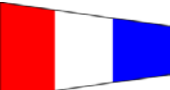
### Ch. 72

Bravo Course	Class Flag
PHRF F	
PHRF G	
JAM A	
JAM B	
JAM C	

Starting order listed is for the first race of the day, order for subsequent races may vary due to conditions and finishes.